

## Data sheet | Item number: 770-683

h-distribution connector; 3-pole; Cod. A; 1 input; 2 outputs; outputs on both sides; 2 locking levers

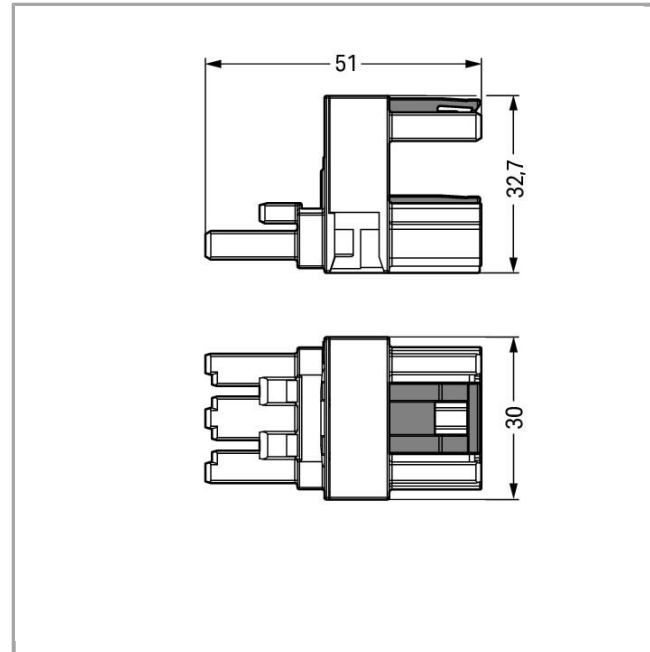

770-683



### Item description

- Protected against mismatching and maintenance-free
- Push-in CAGE CLAMP® spring pressure connection technology allows solid conductors to be simply pushed into a unit
- Two-wire connection per pole for loops or bridges
- Additional variable coding is possible

### Note:

All connectors for mounted installations (snap-in versions for lighting fixtures or devices, all types of PCB and distribution connectors) are factory-equipped with locking levers to ensure plugs and sockets are securely locked. Additional locking levers are only required for flying leads (plug /socket).

### Safety information 1:

Application note for the U.S. market (USR): Some versions may also be used for current interruption in accordance with the UL certificate in select applications with currents below 16 A and voltages up to 600 V. For further information, please contact your local sales office.



## Data

### Electrical data

Note on Contact Resistance

approx. 1mΩ contact resistance

approx. 0.25mΩ contact transition plug/socket

### Ratings per IEC/EN 60664-1

Rated voltage (III / 3)	250 V
Rated impulse voltage (III / 3)	4 kV
Rated current	25 A

### Approvals per UL 1977

Rated voltage per UL 1977 (factory wiring only)	600 V
Rated current per UL 1977 (factory wiring only)	23 A

### Connection data

No. of poles	3
Total number of potentials	3
Ground function	with preceding GND contact

### Geometrical Data

Pin spacing	10 mm / 0.394 inch
Width	30 mm / 1.181 inch
Height	32.7 mm / 1.287 inch
Depth	51 mm / 2.008 inch

### Mechanical data

Coding	A
Mating force of a plug-in connection	approx. 20 ... 70 N (depending on pole number)
Retention force of a plug-in connection	When locked: > 80 N
Unmating force of a plug-in connection	when unlocked: approx. 20 ... 70 N (depending on pole number)
Number of mating cycles	200, without resistive load  100, with resistive load $I_N = 25A$ , tested (4 mm <sup>2</sup> /AWG 12)

Type of distribution connector	h-distribution connector, bi-directional
Marking	L N
Protection class	IP20
Note on protection class	Only in mated condition (These compact connectors are not designed for use in open, easily accessible areas.)
Potential marking	L N

### Plug connection

Contact type (pluggable connector)	Socket/plug
Mismating protection	Yes
Locking of plug-in connection	locking lever
Locking lever	yes

### Material Data

Color	white
Insulating material	Polyamide 66 (PA 66)
Flammability class per UL94	V0
Contact material	Copper or copper alloy, surface-treated
Fire load	0.388 MJ
Weight	22.788 g

### Environmental Requirements

Surrounding air (operating) temperature	-35 ... 85 °C
Processing temperature	-5 ... +40 °C
Continuous operating temperature	-35 ... +85 °C
Note on Continuous Service Temperature	Insulating parts for temperatures ≤ 105 °C

### Commercial data

Country of origin	DE
GTIN	4045454251550
Customs Tariff No.	85366990990





### Approvals / Certificates

#### Country specific Approvals

Logo	Approval	Additional Approval Text	Certificate name
	CCA DEKRA Certification B.V.	EN 61535	2173495.02
	CCA	IEC 61535	NL-32105

DEKRA Certification B.V.

## Ship Approvals



Logo	Approval	Additional Approval Text	Certificate name
	<b>ABS</b> American Bureau of Shipping	-	14- HG1241528- PDA
	<b>DNV GL</b> Det Norske Veritas, Germanischer Lloyd	-	TAE00001Z6
	<b>DNV GL</b> Det Norske Veritas, Germanischer Lloyd	-	TAE00001Z6
	<b>LR</b> Lloyds Register	IEC 61984	02/20050 (E6)

## UL-Approvals

Logo	Approval	Additional Approval Text	Certificate name
	<b>cURus</b> Underwriters Laboratories Inc.	UL 1977	E45171 Sec. 9

## Compatible products

## protection

	<b>Item no.: 770-201</b> Lockout cap; 12-pole, separable; 12-pole; for sockets	770-201
	<b>Item no.: 770-221</b> Lockout cap; for socket; 12-pole; separable	770-221
	<b>Item no.: 770-360</b> Lockout cap; for plugs; 5-pole; separable	770-360

## assembling

	<b>Item no.: 770-623</b> Mounting plate; 3-pole; for distribution connectors; Plastic	770-623
	<b>Item no.: 770-673</b> Mounting plate; 3-pole; for distribution connectors; Plastic	770-673



Downloads

Documentation

Bid Text

770-683	Apr 4, 2012	doc	Download
WINSTA MIDI 3-polig		23.6 kB	

---

CAD/CAE - Smart Data

CAD data

3D Download 770-683	URL	Download
---------------------	-----	----------

---

Subject to changes.

---